

# PALISSADE CONE TABLE

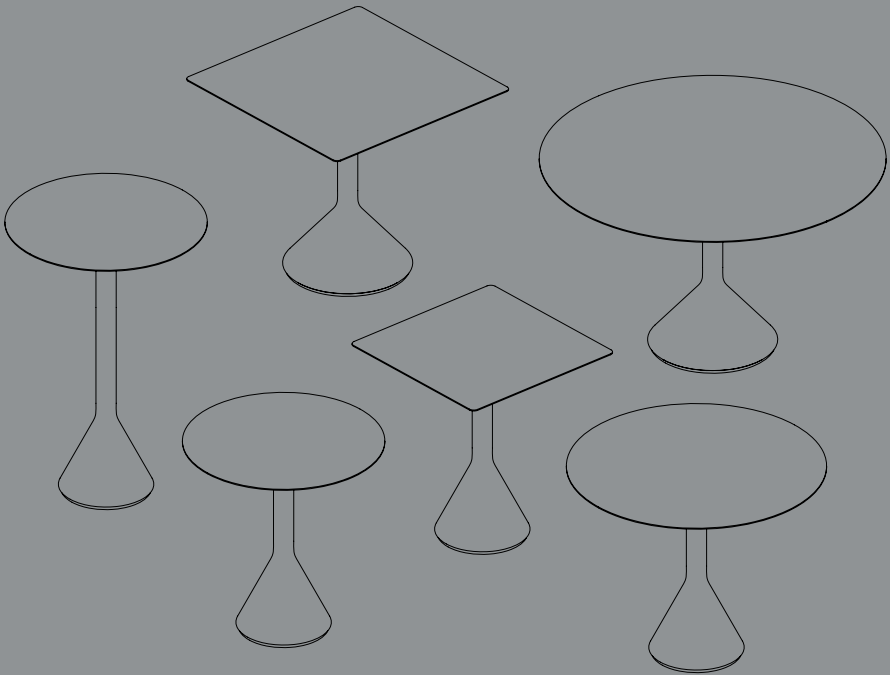

DESIGN BY RONAN & ERWAN BOURULLEC

**HAY**



- PARTS -

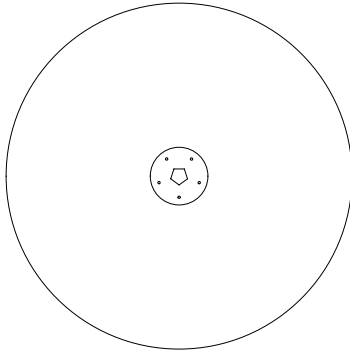

**A** Tabletop x1

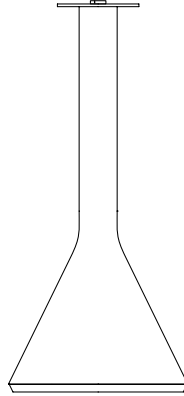

**B** Base x1

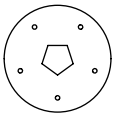

**C** Washer x1



**D** Allen key x1



**E** Screw x5

Protect the table top from scratches and other damage while assembling.

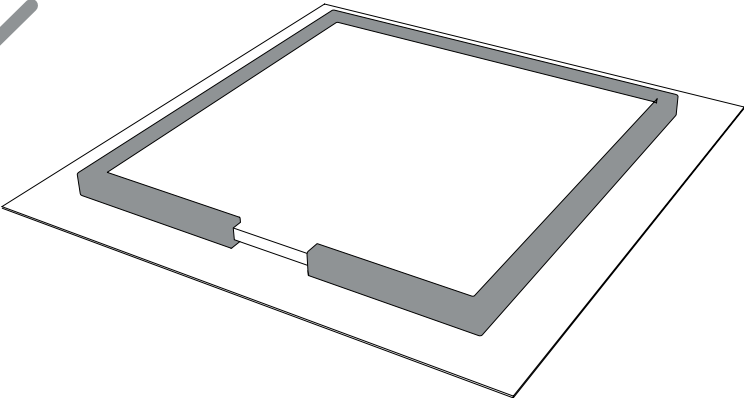
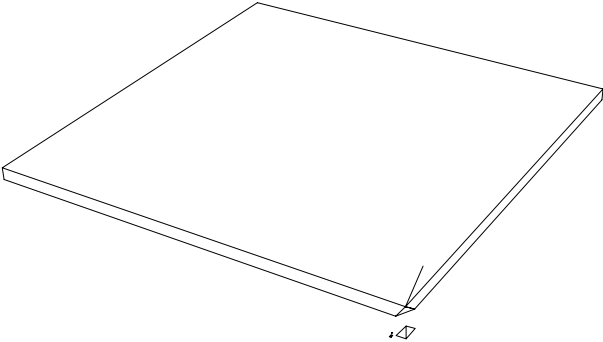

1.

Place the **A** part on top of the **B** part, inserting the **C** part in between them.

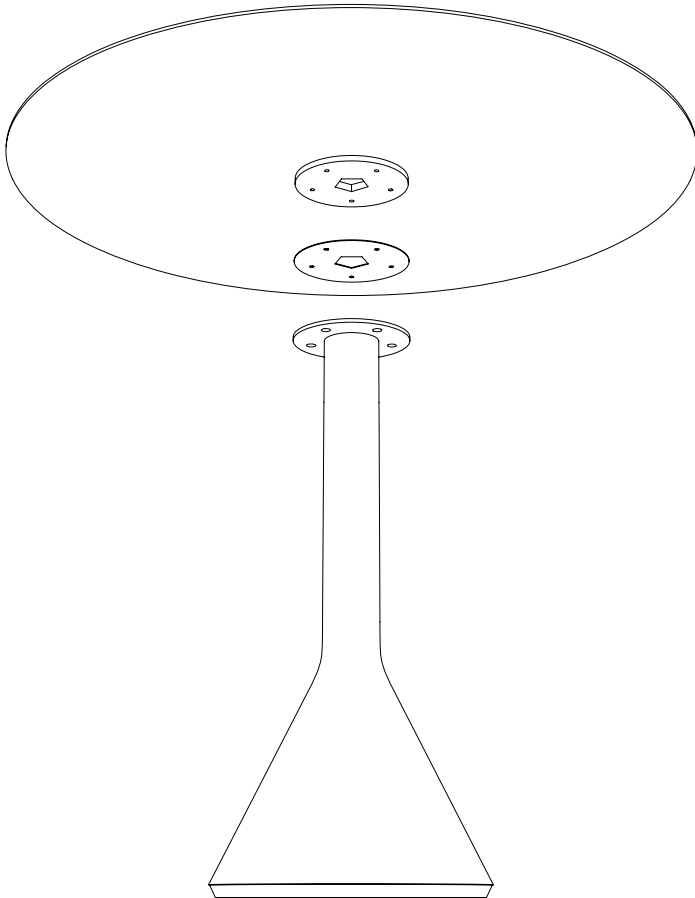

2.

Fasten the screws **E** with the Allen key **D**. Make sure all screws are inserted before tightening them completely.

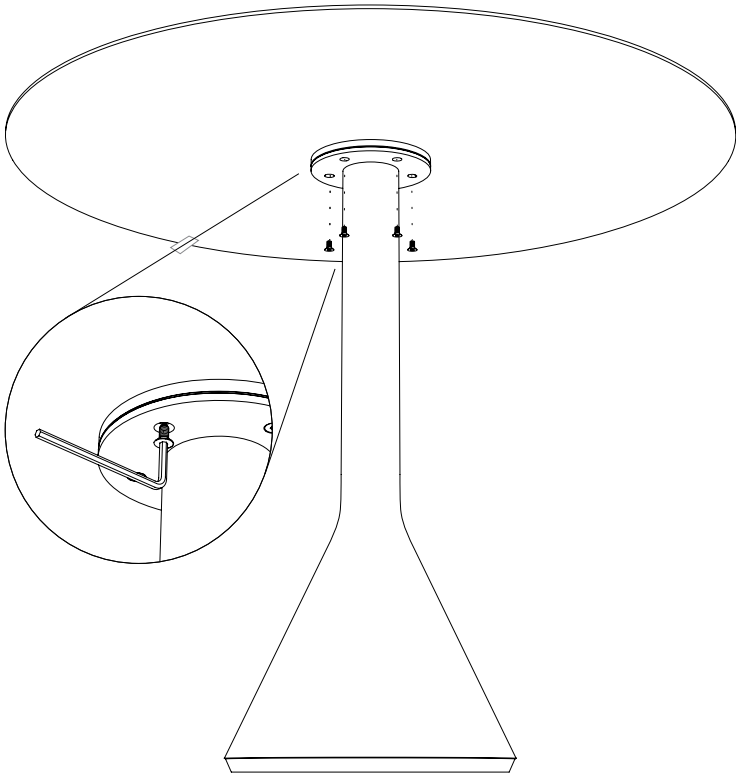

3.

Done!

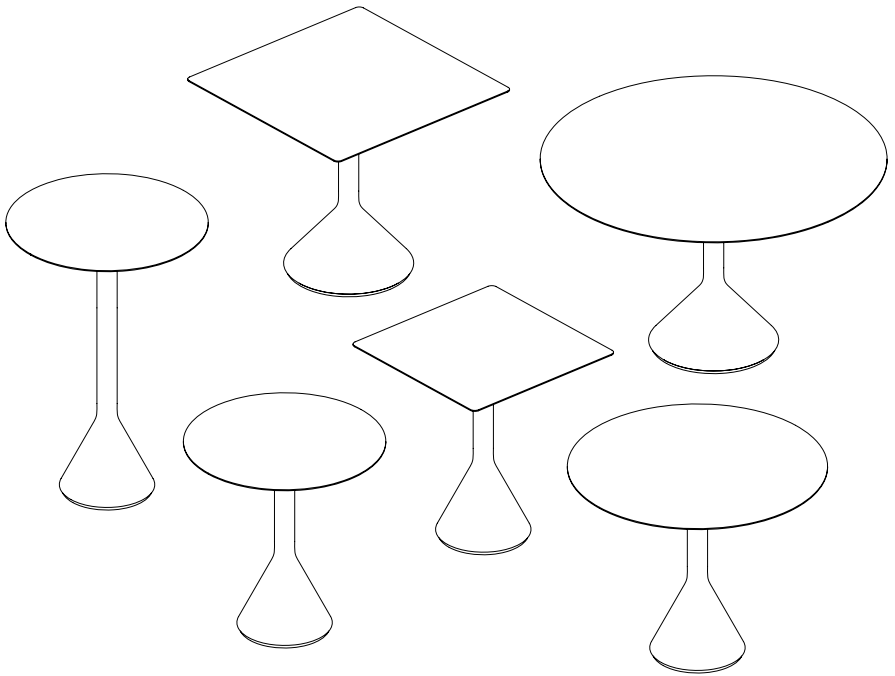

- CARE & MAINTENANCE -

Our Care & Maintenance offers guidance for optimal maintenance of your HAY product. It includes advice and instructions on cleaning and caring for specific materials to prolong the life of your furniture.



Please find our Care & Maintenance guide by scanning the QR code



You can find more relevant information on Palissade Cone Table by scanning the QR code

You can also find the same information here  
[hay.dk/downloads](http://hay.dk/downloads)





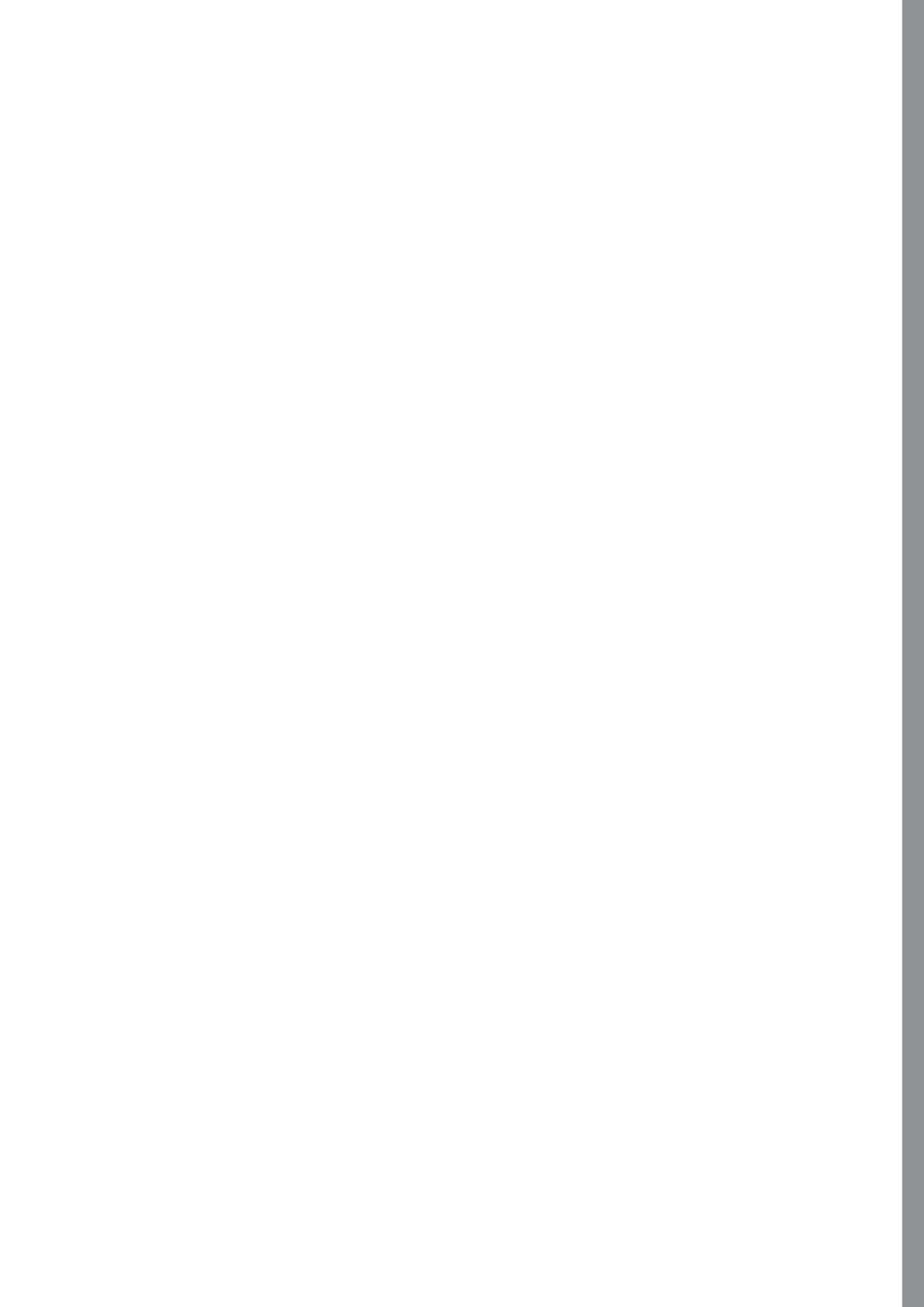



Havnen 1 8700 Horsens Denmark  
+45 3164 6000 / hay@hay.com

10/01/2023

**HAY**