

FRITZ HANSEN



DRACHMANN
PRODUCT FACT SHEET

DRACHMANN

The signature Drachmann series draws inspiration from the beautiful garden of Danish romantic poet and painter, Holger Drachmann. A careful balance of Nordic nostalgia and modern simplicity underlies its enduring popularity. Made of 100% FSC-certified teak wood selected for its strength and beauty over time, untreated teak will take on a beautiful silver-grey patina.

PRODUCT TYPE

Armchair
Bench
Table

ENVIRONMENT

Outdoor

DESIGNER

Bernt Santesson
Mogens Holmriis

MODELS

Chair
Bench 120
Bench 165
Bench 200
Table Ø126
Table 86
Table 156
Table 190

MATERIAL

Teak (Untreated)

FEATURES

- Umbrella opening (Table: Ø126, 156, 190)
- Seat cushion (Find further details on p. 6)

MADE-TO-ORDER

N/A

CERTIFICATION

- FSC™ FSC-C120451: The wood used for Drachmann is FSC-certified (FSC 100%). The FSC-certification ensures the wood is from responsible and environmentally managed forests that preserve the natural surroundings and support the local community.

For more information about environment and manufacturing processes, please download our environmental information sheet at: [fritzhansen.com](https://www.fritzhansen.com)

TEST

- Chair: ANSI/BIFMA X5.4-2020
- Table Ø126: EN 581-1:2017, EN 581-3:2017, ANSI/BIFMA X5.5 2021

SPECIFICATIONS

Wood: New wooden, teak furniture has natural colour differences found in the freshly cut wood. Once the furniture has been exposed to the sun, these colour differences will even out. As a natural part of the aging process, the surface of teak will change when first being exposed to rain; this is the first stage of a process of wood that ages with beauty.

WEIGHT

Chair: 14,6 kg / 32.2 lb
Bench 120: 22,3 kg / 49.2 lb
Bench 165: 24,9 kg / 54.9 lb
Bench 200: 30,4 kg / 66.9 lb
Table Ø126: 45 kg / 99.2 lb
Table 86: 18,9 kg / 41.6 lb
Table 156: 28,5 kg / 62.7 lb
Table 190: 31,8 kg / 70 lb

COUNTRY OF ORIGIN

Wood origin: Indonesia

PRE-ASSEMBLED

No

PACKAGING

The units are shipped in a recycled cardboard box. All packaging material can be recycled.

CLEANING AND CARE

Find recommendations for cleaning and care at: [fritzhansen.com/maintenance](https://www.fritzhansen.com/maintenance)

REPAIR, DISPOSAL AND REUSE

In case of repair and disposal the units can be disassembled into parts. All parts can be recycled. Check local regulations for recycling options and whether there is potential for reuse.

WARRANTY

Fritz Hansen provides a five-year warranty on standard products against defects in materials and workmanship.

Additional warranty conditions can be found at: [fritzhansen.com/warranty](https://www.fritzhansen.com/warranty)

DIMENSIONS (CHAIR/BENCHES)

CHAIR

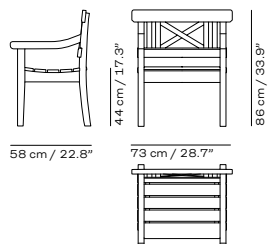

BENCH 120

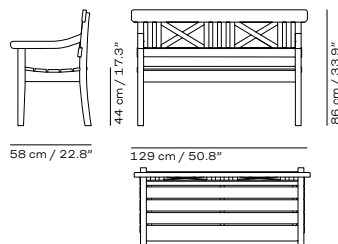

BENCH 165

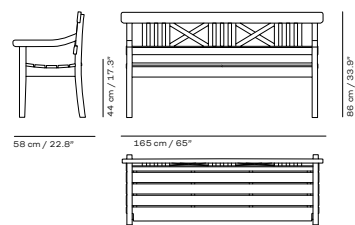

BENCH 200

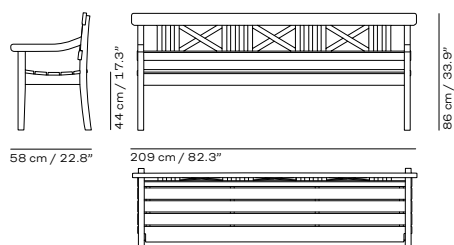

DIMENSIONS (TABLES)

TABLE Ø126

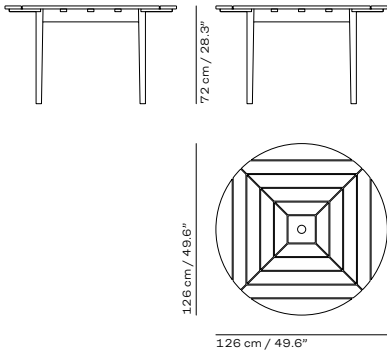

TABLE 86

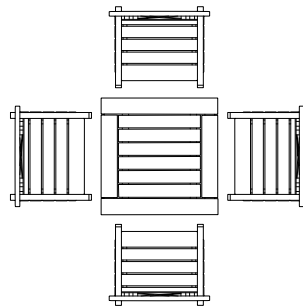
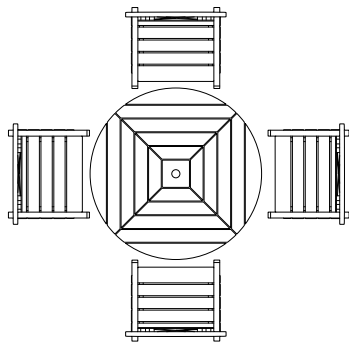
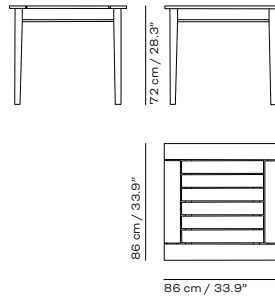

TABLE 156

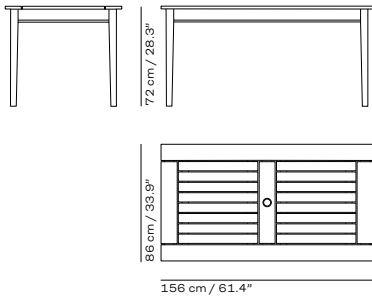
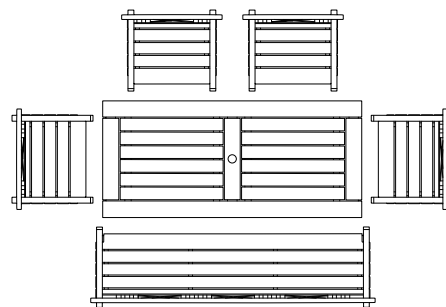
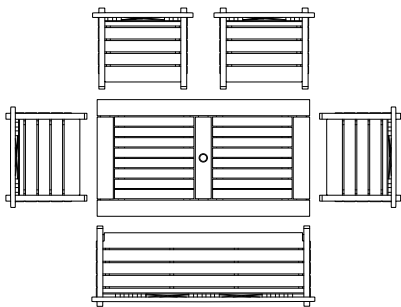
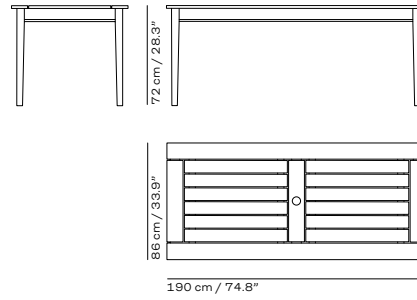

TABLE 190



VARIANTS

CHAIR



TEAK
S1040520

BENCH 120



TEAK
S1040505

BENCH 165



TEAK
S1040510

BENCH 200



TEAK
S1040515

TABLE Ø126



TEAK
S1042005

TABLE 86



TEAK
S1042010

TABLE 156



TEAK
S1042015

TABLE 190



TEAK
S1042020

CUSHIONS

DESCRIPTION

Drachmann cushions are custommade to fit the series and are highly weather-resistant. The upholstery textiles are Oeko-Tex® certified, colourfast, lightfast, water and dirt-repellent, and mildew-resistant. The cushion dries exceptionally quickly as the foam has an open-cell structure that allows water and air to pass through. The quick-dry outdoor foam provides a firm and comfortable texture that remains the same year after year.

ENVIRONMENT

Outdoor

DESIGNER

Skagerak Design

MODELS

Chair Cushion
Bench 120 Cushion
Bench 165 Cushion
Bench 200 Cushion

MATERIAL

Outdoor textile
Quickdry outdoor foam

The cushion range for the UK/IE is different from the main collection in order to meet local fire regulations*.

UPHOLSTERY

The following selection of textiles* is available:



MADE-TO-ORDER

N/A

CERTIFICATION

Textiles: Oeko-Tex®.

For more information about environment and manufacturing processes, please download our environmental information sheet at: fritzhanzen.com

TEST

N/A



SPECIFICATIONS*

The quickdry outdoor foam provides a firm and comfortable seat that retains its shape year after year. The open-cell structure allows both water and air to pass through ensuring the cushion dries exceptionally quickly, even after a heavy downpour. To ensure cushions remain beautiful over time, it is good practice to avoid them being left wet for prolonged periods, e.g., by turning them upright to let water run off or storing them in a dry environment.

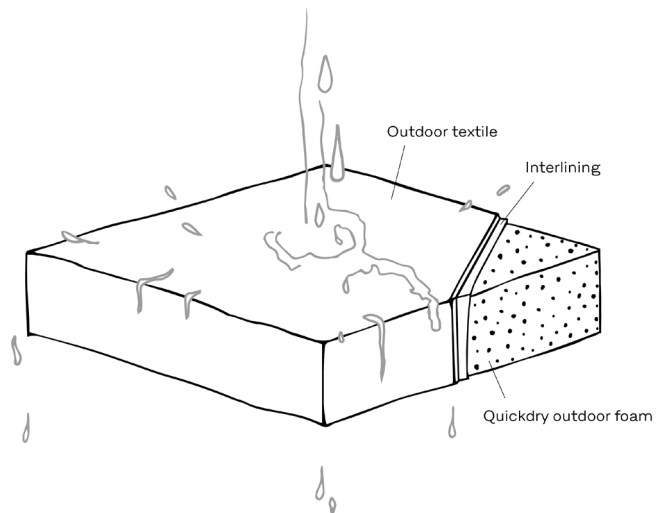

WEIGHT

Chair Cushion: 0,9 kg / 2.0 lb
Bench 120 Cushion: 1,6 kg / 3.5 lb
Bench 165 Cushion: 2,2 kg / 4.7 lb
Bench 200 Cushion: 2,7 kg / 6.0 lb

COUNTRY OF ORIGIN

Produced in: Poland, Spain

*For details specific to UK/IE go to p. 9.

PRE-ASSEMBLED

Yes

PACKAGING

The units are wrapped in a plastic bag.
All packaging material can be recycled.

CLEANING AND CARE

Find recommendations for cleaning and care at:
fritzhansen.com/maintenance

REPAIR, DISPOSAL AND REUSE

In case of repair and disposal the units can be disassembled into parts. All parts can be recycled. Check local regulations for recycling options and whether there is potential for reuse.

WARRANTY

Fritz Hansen provides a five-year warranty on standard products against defects in materials and workmanship.

Additional warranty conditions can be found at:
fritzhansen.com/warranty

DIMENSIONS

CHAIR CUSHION

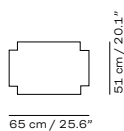

BENCH 120 CUSHION

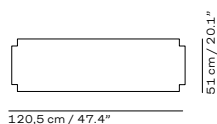

BENCH 165 CUSHION

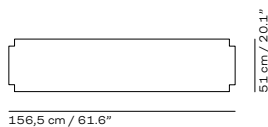

BENCH 200 CUSHION

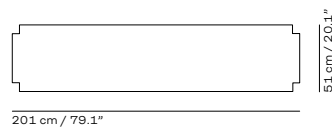

VARIANTS (UK/IE)

CHAIR CUSHION



LEMON/SAND
STRIPE
1961090



LIGHT APRICOT/
DARK GREEN STRIPE
1961091

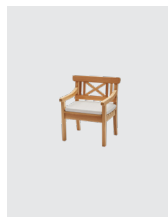

PAPYRUS
1961199



CHARCOAL
1960884



ASH
1960883

BENCH 120 CUSHION



LEMON/SAND
STRIPE
1961092



LIGHT APRICOT/
DARK GREEN STRIPE
1961093



PAPYRUS
1961200



CHARCOAL
1960878



ASH
1960877

BENCH 165 CUSHION



LEMON/SAND
STRIPE
1961094



LIGHT APRICOT/
DARK GREEN STRIPE
1961095



PAPYRUS
1961201



CHARCOAL
1960880



ASH
1960879

BENCH 200 CUSHION



LEMON/SAND
STRIPE
1961096



LIGHT APRICOT/
DARK GREEN STRIPE
1961097



PAPYRUS
1961202



CHARCOAL
1960882



ASH
1960881

IMPORTANT NOTE!

Under current UK law, Fritz Hansen is not able to provide outdoor cushions and pillows with the same filling as the regular collection. We still offer cushions and pillows in an outdoor textile with weatherproof properties, but the filling is not weatherproof due to stringent (indoor) fire regulations. We therefore recommend that you bring cushions and pillows indoors in heavy rain and when they are not in use.

The FR cold foam provides a firm and comfortable seat that retains its shape year after year. The FR cold foam is not weather resistant, and therefore it is recommended to store the cushions indoor when not in use and during heavy downpour. To ensure cushions remain beautiful over time, it is good practice to avoid them being left wet for prolonged periods, e.g., by turning them upright to let water run off or storing them in a dry environment.